

OUR PRODUCTS

SAFEWAZE products are durable, practical and comfortable, leaving you with a peace of mind to work efficiently and safely. SAFEWAZE meets applicable OSHA and ANSI standards. Our products are designed with the worker in mind, because it is details that make the difference.

Product Sizing

Harnesses with belts are sized according to waist measurements.

Size	Waist Measurement	Size	Waist Measurement
S	26" - 32"	XL	40" - 46"
M	32" - 36"	XXL	46" - 52"
L	36" - 40"	HW	52" above

6'6"																	
6'4"																	
6'																	
5'10"																	
5'8"																	
5'6"																	
5'4"																	
5'2"																	
5'																	
	130	150	170	190	210	230	250	270	290	310	330	350	370	390	400	420	

Large/
X-Large

XXL

Heavyweight

Small/
Medium

TRAINING



You've invested in fall protection equipment, now learn how to put it to use – safely and effectively. SAFEWAZE offers a full range of training programs to help ensure that your needs are met when it comes to understanding regulatory and application issues regarding fall protection. For your convenience, these programs can be scheduled for your location, or at our North Carolina facility.

Our training programs include but are not limited to:

- Fall Protection 101
- Authorized Inspector
- Competent Person Fall Protection
- Train the Trainer

ENGINEERING SERVICES

Sometimes, your fall protection solution cannot come out of a box. SAFEWAZE offers a full line of engineering services that include:

Our training programs include but are not limited to:

- Site Assessment
- Project Design
- Product Fabrication
- Project Install
- Structural Certification

Our products include:

- Horizontal Lifelines
- Rigid Rail
- Ladder Safety Systems
- Customized Roof Systems



HARNESSES

PRO+ / PRO / V-LINE

PRO+



SERIES FEATURES:

- Comfort Shoulder pads
- Quick release chest buckle
- Convenient lanyard keepers
- Fall arrest indicators
- Easy adjustment buckles

A Flex Vest Harness

FS-FLEX185

- Single D-ring
- Grommet leg straps
- Sizes: S/M, L/XL, 2XL

Other Options:

FS-FLEX285 3 D-rings



SafeWaze Pro Plus is a premium line of fall protection products. The Pro Plus line features high-end harnesses made with our Flex material, quick connect and release, and optional extra padding which are ideal for those who are looking for maximum comfort and mobility. This series also includes products and accessories designed for specific industries including: wind energy, oil & gas, solar, utilities, and welding.

HARNESSES

PRO+ / PRO / V-LINE

PRO+



B Flex Construction Harness

FS-FLEX360

- Free floating comfort back pad
- Removable grommet belt
- Grommet leg straps
- Side positioning D-rings
- Sizes: S, M, L, XL, 2XL



C Flex Premium Vest Harness

FS-FLEX280

- Quick release leg buckles
- Single D-ring
- Sizes: S/M, L/XL, 2XL

Other Options:

FS-FLEX250 Cool air leg pads

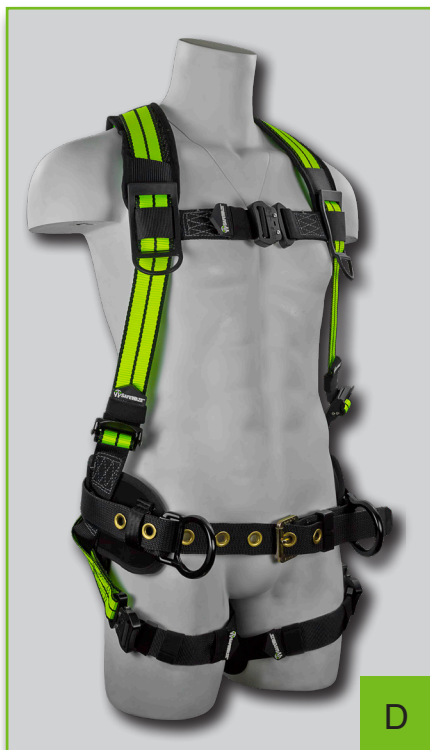

D Flex Premium Construction Harness

FS-FLEX253

- Free floating comfort back pad
- Removable grommet belt
- Quick release leg buckles
- Comfort leg pads
- Side positioning D-rings
- All aluminum hardware
- Sizes: S, M, L, XL, 2XL

Other Options:

FS-FLEX253-FD Front D-ring



E Flex Iron Workers Harness

FS-FLEX270

- Sewn-in comfort back pad
- Removable grommet belt
- Grommet leg straps
- Grommet adjustments
- Side positioning D-rings
- Sizes: S, M, L, XL, 2XL

HARNESSES

PRO+ / PRO / V-LINE

PRO+

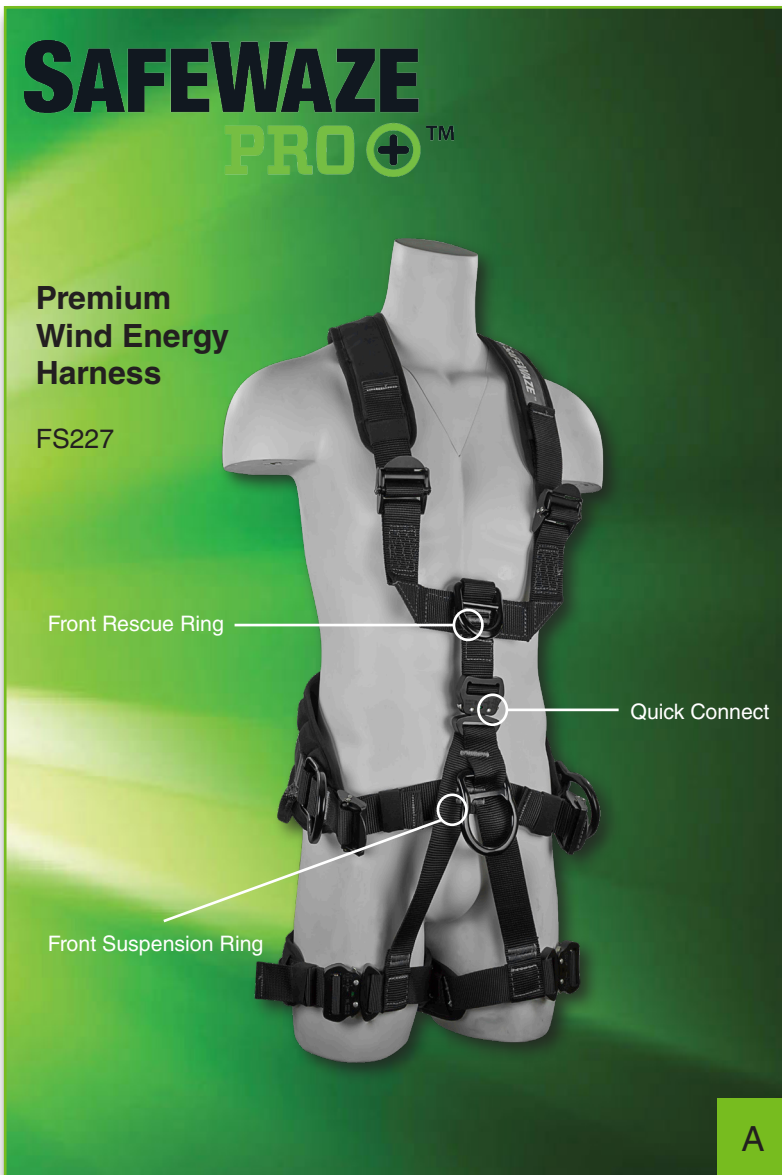

D Premium Wind / Rescue Harness

FS227

- Aluminum hardware
- Front rescue ring
- Front suspension ring
- Side positioning rings
- All quick release buckles
- Backrest ergonomically designed to improve comfort and support
- Design prevents neck irritation and shoulder strap slip
- Sizes: S/M, L/XL, 2XL

Other Options:

FS227-T Convert the FS227 to a tower erection harness with the comfortable and versatile tower erection seat. Easily adapts to our patent pending FS227 harness.



SAFEWAZE
PRO+™

These products are designed specifically for the wind energy, tower erection, and oil & gas industry. They are durable, comfortable and practical for the demands and requirements of these industries.

HARNESSES

PRO+ / PRO / V-LINE

PRO+



B



C



D



E

B Wind Energy Harness

FS377

- Light weight aluminum hardware
- Front rescue D-ring
- Free floating comfort back pad
- Grommet legs and belt
- Front lanyard keepers
- Fall indicators
- No tangle D-ring pad reduces web knotting, and relieves D-ring back pressure
- Aluminum side positioning D-rings
- Sizes: S, M, L, XL, 2XL

C Flex Premium Wind Energy Harness

FS-FLEX253-FD

- Free floating comfort back pad
- Removable grommet belt
- Quick release leg buckles
- Cool air leg pads
- Side positioning D-rings, and Front D-ring
- Sizes: S, M, L, XL, 2XL

D Oil Derrick Harness

FS77635-OD

- Derrick pad connections that incorporates work positioning rings with a ridged core, and tongue buckle belt
- Chest D-ring, and side positioning D-rings
- Sizes: S/M, L/XL, 2XL

FS77635-OD-PAD *Oil Derrick Pad
Replacements may be purchased separately

E Premium Harness with Detachable Seat

FS-FLEX255

- Pro Plus comfort shoulder pad
- Detachable suspension seat with 2 D-rings and aluminum brace
- Dorsal, front, and side positioning D-rings
- Quick release chest and leg buckles
- Sizes: S, M, L, XL, 2XL

HARNESSES

PRO+ / PRO / V-LINE

PRO+



SERIES FEATURES:

Dielectric/Arc-Flash

- Hardware is light weight
- Dielectric manufactured design
- Dielectric hardware 35kv rated
- 40 Cal. rating
- Meets ASTM F887 electric arc-flash requirements

Fired Rated

- Nomex® cover / Kevlar® core
- Fire rated harness 700° F
- Ideal for critical use area
- Passes NFPA 1971/1981 heat test and flame test
- Webbing 7,000 lbs tensile strength

Welding

- Nomex® cover / Polyester core
- Prevents welding burn slag
- Surface at 700° F

A Arc-Flash Quick Connect Harness

SW77225-UT-3QC

- Dielectric quick connect chest and legs
- Single D-ring
- Sizes: S/M, L/XL, 2XL

Other Options:

SW77225-UT-QC Pass through chest, and dielectric quick connect leg straps

SW77225-UT-2QC-SL Pass through chest, dielectric quick connect legs, and soft loop back D-ring



These products are designed for utility, fire-rated, and welding applications.

HARNESSES

PRO+ / PRO / V-LINE

PRO+



B



C



D

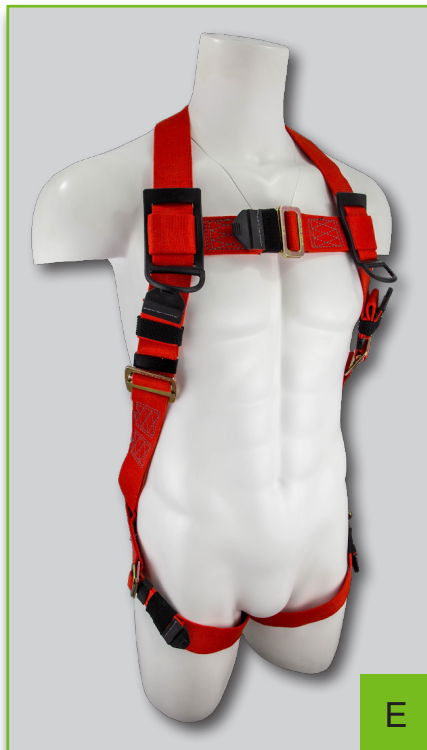

E

B Arc-Flash Pullover Harness

SW77125-UT-QC

- Pullover style
- Advanced D-ring design
- No-tangle D-ring pad reduces web knotting and relieves D-ring back pressure
- Dielectric dorsal D-ring
- Dielectric quick connect legs
- Reinforced web loop front rescue ring attachment
- Sizes: S/M, L/XL, 2XL

Other Options:

SW77125-UT-QC-SL Soft loop back D-ring

C Hi-Vis Harness

FS-HIVIS185

- Reflective full body harness for easier, and quicker observation
- Meets Class I high visibility requirements of ANSI/ISEA 107-1999
- Includes grommet legs and no tangle X-Pad
- Sizes: S/M, L/XL, 2XL

D Fire Rated Harness

FS77325-FR

- 5 point adjustments
- Pass through leg buckles
- Single D-ring
- Sizes: S, M, L, XL, 2XL

Other Options:

FS77326-FR 3 D-rings

E Welding Harness

FS77425-WE

- 5 point adjustments
- Pass through leg buckles
- Single D-ring
- Sizes: S/M, L/XL, 2XL

Other Options:

FS77426-WE 3 D-rings

HARNESSES

PRO+ / PRO / V-LINE

PRO

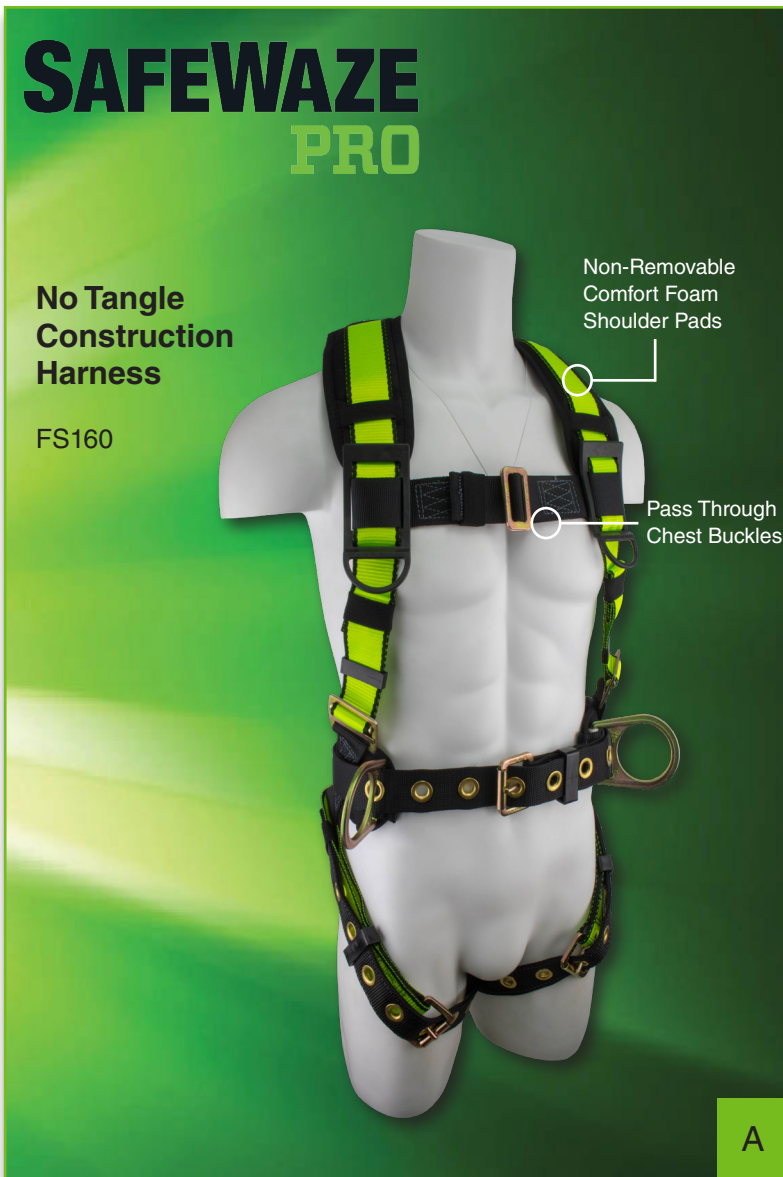

SERIES FEATURES:

- Non-Removable comfort shoulder pads
- Pass through chest buckles
- Fall arrest indicators
- Convenient lanyard keepers

A Construction Harness

FS160

- Premium internal foam back support
- Removable grommet belt
- Adjustable buckles
- Free floating back pad
- Grommet leg straps
- Side positioning D-rings
- Sizes: S, M, L, XL, 2XL

Other Options:

- FS170** Fixed back pad designed for tool bags
- SW160-QC** Quick-connect chest and legs

SAFEWAZE
PRO™

Premium components position the PRO brand as a premier value product. Pro incorporates high quality performance with competitive pricing.

HARNESSES

PRO+ / PRO / V-LINE

PRO

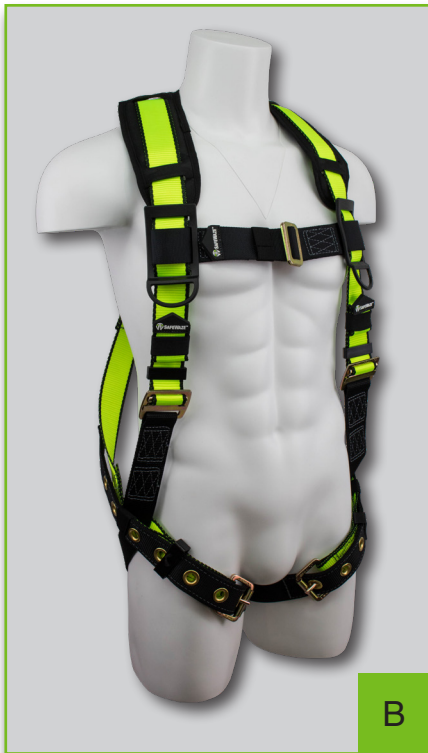

B Vest Harness with Grommet Legs

FS185

- Grommet leg straps
- Single D-ring
- Sizes: S/M, L/XL, 2XL

Other Options:

FS285 3 D-rings

C Vest Harness

FS280

- Pass through leg buckles
- Single D-ring
- Sizes: S/M, L/XL, 2XL

Other Options:

FS281 3 D-rings

SW280-QC Quick-connect chest and legs



D Heavy Weight Harness

SW99280-HW

- Adjustable to fit 3x-4x
- Grommet legs
- Rated up to 420 lbs
- Single D-ring

Other Options:

SW99281-HW 3 D-rings

HARNESSES

PRO+ / PRO / V-LINE

V-LINE



SERIES FEATURES:

- Economical
- Pass through chest buckle
- Convenient lanyard keepers
- Velcro label protector on back strap
- Single back D-ring

A Construction Harness

FS99160-E

- Floating foam back pad
- Multiple adjustment points
- Removable grommet belt
- Grommet leg straps
- 2 side D-rings for positioning
- Sizes: S, M, L, XL, XXL

SAFEWAZE V-LINE

Safewaze V-LINE products are for markets that demand quality and value. The Vline Series offers many options for diverse fall protection requirements.

HARNESSES

PRO+ / PRO / V-LINE

V-LINE

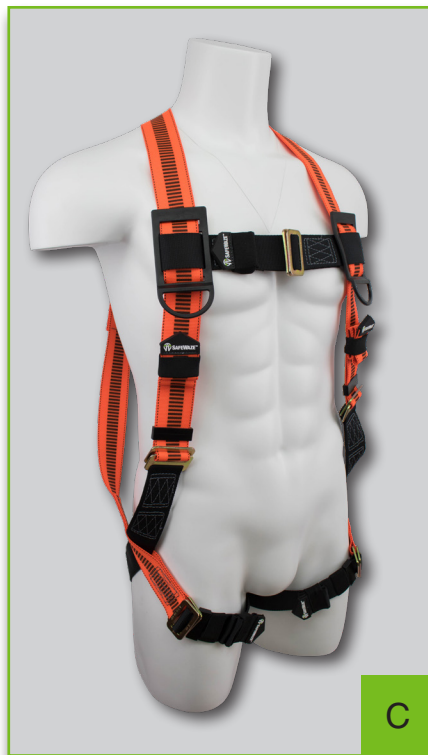
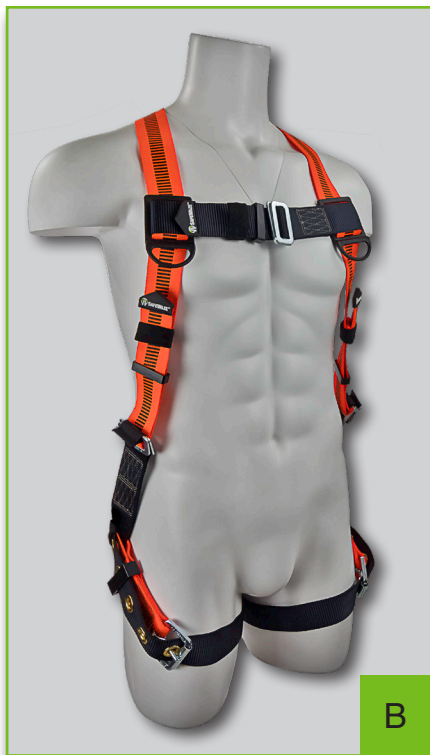

B Harness with Grommet Legs

FS99185-E

- Multiple adjustment points
- Grommet leg straps
- Single D-ring
- Universal sizing (S - XL)

Other Options:

FS99185-EFD Back and front D-ring

FS99285-E Back D-ring; 2 side D-rings for positioning; Multiple adjustment points

C Vest Harness

FS99280-E

- Multiple adjustment points
- Pass through leg buckles
- Single D-ring
- Universal sizing (S - XL)

Other Options:

FS99281-E Back D-ring; 2 side D-rings for positioning; multiple adjustment points; Universal sizing

D 4 D-ring Harness

FS99281-EFD

- Multiple adjustment points
- Pass through leg buckles
- 2 side D-rings for positioning
- 1 front D-ring for rescue and suspension
- Universal sizing (S - XL)

E V-LINE Cross Over / 4 D-ring Harness

FS99281-EFD-X

- Pullover style
- Pass through leg buckles
- 2 side D-rings for positioning
- 1 front D-ring for rescue and suspension
- Universal sizing (S - XL)

KITS

PRO / V-LINE COMPLIANCE

PRO COMPLIANCE



A FS126

- FS280: Harness
- FS560: Lanyard
- FS8125: Carrying bag
- S/M – L/XL – XXL

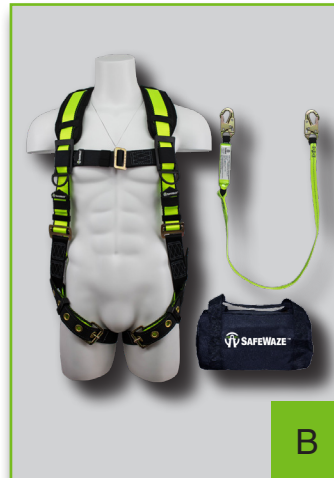

B FS141

- FS185: Harness
- FS560: Lanyard
- FS8125: Carrying bag
- S/M – L/XL – XXL



C FS133

- FS185: Harness
- FS580: Lanyard
- FS8125: Carrying bag
- S/M – L/XL – XXL



D FS146

- FS185: Harness
- FS-FSP1407-W: Retractable
- FS8125: Carrying bag
- S/M – L/XL – XXL



E FS143

- FS185: Harness
- FS-EX1006-W: Retractable
- FS8125: Carrying bag
- S/M – L/XL – XXL



F FS147

- FS185: Harness
- FS456: Lanyard
- FS8125: Carrying bag
- S/M – L/XL – XXL

KITS

PRO / V-LINE COMPLIANCE

V-LINE COMPLIANCE



G FS120-E-1118DC-BP

- FS99280-E: Pass through legs harness
- FS88560-E: Single leg lanyard
- FS700-50: 50' Rope lifeline
- FS1118-DC: Removable-Non trailing
- FS870: Reusable roof anchor
- FS8185: Convenient heavy duty carry bag
- Universal sizing (S – XL)



H FS120-E-1118DC

- FS99280-E: Pass through legs harness
- FS88560-E: Single leg lanyard
- FS700-50: 50' Rope lifeline
- FS1118-DC: Removable-Non Trailing rope grab
- FS870: Reusable roof anchor
- Bucket with lid
- Universal sizing (S – XL)

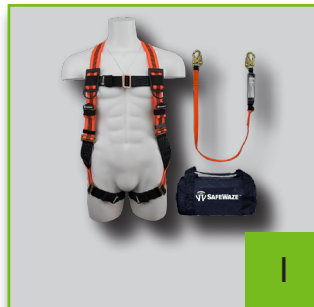

I FS126-E

- FS99280-E: Pass through legs harness
 - FS88560-E: Single leg lanyard
 - FS8125: Carrying bag
 - Universal sizing (S – XL)
- Other Options:**
FS129-E same as FS126-E bundled in clear plastic bag



J FS-ROOF-E

- FS99280-E: Pass through legs harness
- FS870: Reusable roof anchor
- FS700-50GA-3E: 50' Rope lifeline
- Bucket with lid
- Universal sizing (S – XL)

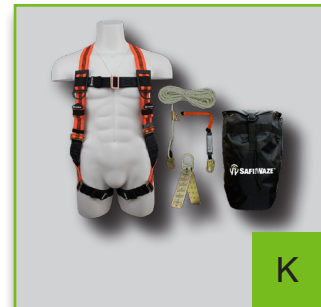

K FS-ROOF-E-BP

- FS99280-E: Pass through legs harness
- FS870: Reusable roof anchor
- FS700-50GA-3E: 50' Rope lifeline
- FS8185: Convenient heavy duty carry bag
- Universal sizing (S – XL)

KITS
(PRO, & VLINE)

CONNECTORS

RETRACTABLES / ENERGY ABSORBING LANYARDS

CLASS B RETRACTABLES

6' Web Retractable (Single-leg series)



019-5045

- Aluminum snap hook
- 6' Length
- Meets ANSI Z359.14-2014 and ANSI/ASSE A10.32 - OSHA 1910.66 and OSHA 1926.502
- 360° Rotating & 180° Pivoting attachment point
- Rugged nylon housing
- Durable shock pack & protective label cover
- Steel carabiner included

6' Single-Leg Series Options:

- *This compact unit comes in a wide variety of hook and connection configurations.*

6' Web Retractable (Dual-leg series)



019-5054

- Steel rebar hook
- 6' Length
- Meets ANSI Z359.14-2014 and ANSI/ASSE A10.32 - OSHA 1910.66 and OSHA 1926.502
- 360° Rotating & 180° Pivoting attachment point
- Rugged nylon housing
- Durable shock pack & protective label cover
- 9013 Behind the web bracket included

6' Dual-Leg Series Options:

- *This compact unit comes in a wide variety of hook and connection configurations.*

CONNECTORS

RETRACTABLES / ENERGY ABSORBING LANYARDS

CLASS A RETRACTABLES



F FS-FSP1407-W

- 7' Length
- Engraved housing
- Fall indicator sewn into webbing
- 3,600 lbs gate-rated snap hook
- Meets ANSI Z359.14 - Class A Standards

SafeWaze retractable lifelines are designed to be used as a single person fall protection device. We offer many configurations of our Class A self retracting lifelines to suit virtually any work environment.

RETRACTABLES & LANYARDS



G

G FS-FSP1407-W-TBH

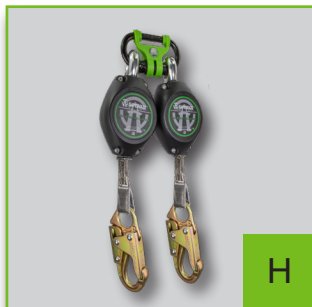

H

H FS-FSP15075-W-BWB

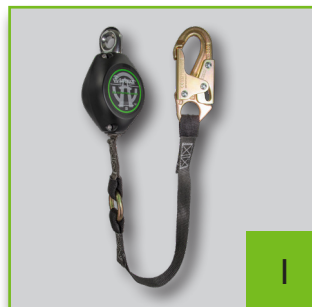

I

I FS-FSP1409-W

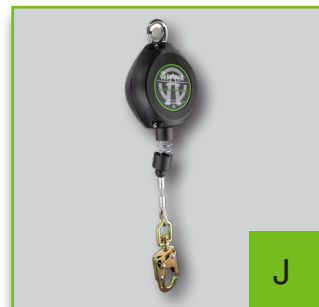

J

J FS-FSP1211-G

7' Web Options:

- FS-FSP1407-W-RBH 7' with rebar hook
- FS-FSP1407-W-TBH 7' Tie back hook
- FS-FSP14075-W-TBH 7' Dual leg tie back with tie back hooks
- FS-FSP14075-W 7' Dual leg and snap hooks
- FS-FSP14085-W-RBH 7' Dual leg and rebar hooks
- FS-FSP15075-W-BWB 7' Dual leg (in webbing) bracket and snap hooks
- FS-FSP15085-W-RBH-BWB 7' Dual leg (in webbing) bracket and rebar hooks

9' Web Options:

- FS-FSP1409-W 9' with snap hook
- FS-FSP1409-W-RBH 9' with rebar hook
- FS-FSP1409-W-DL 9' Dual leg and snap hooks
- FS-FSP1409-W-DL-RBH 9' Dual leg and rebar hooks
- FS-FSP1409-W-DL-BWB 9' Dual leg (in webbing) bracket and snap hooks
- FS-FSP1409-W-DL-RBH-BWB 9' Dual leg (in webbing) bracket and rebar hooks

11' Web Options:

- FS-FSP1411-W 11' with snap hook
- FS-FSP1411-W-RBH 11' with rebar hooks
- FS-FSP14095-W 11' Dual leg and snap hooks
- FS-FSP14095-W-RBH 11' Dual leg and rebar hooks

*Safewaze Retractable include Standard Steel Carabiner

CONNECTORS

RETRACTABLES / ENERGY ABSORBING LANYARDS

7' WEB RETRACTABLE SERIES



7' Web Retractable with Aluminum Locking Snap Hook *(Single-leg series)*

018-5009

- Aluminum locking snap hook
 - 7' Length
 - High-strength transparent plastic housing for enhanced unit inspection
 - Revolutionary breaking system that alleviates the need for an external shock pack
 - .77in (19.5 mm) Ultrahigh molecular weight webbing
 - Product data label incorporated into webbing and protected by cover
 - Steel carabiner included
- Available in aluminum or steel rebar hook*

These units are lightweight with a durable translucent housing that not only looks unique, but protects the internal components from debris and contamination. The housing also makes for easy viewing and inspection of the webbing, reserve line, and pawl assembly.



7' Web Retractable with Aluminum Rebar Hooks *(Dual-leg series)*

018-5027

- Aluminum rebar hooks
 - 7' Length
 - High-strength transparent plastic housing for enhanced unit inspection
 - Revolutionary breaking system that alleviates the need for an external shock pack
 - .77in (19.5 mm) Ultrahigh molecular weight webbing
 - Product data label incorporated into webbing and protected by cover
 - 9013 Behind the Web Bracket included
- Available in aluminum snap or forged steel rebar hooks*

These retractables also feature an industry exclusive internal breaking system that increases the dependability of the unit while eliminating the need for an external shock pack. The dual legs come in a variety of attachment and hook configurations.

CONNECTORS

RETRACTABLES / ENERGY ABSORBING LANYARDS

11' LEADING EDGE RETRACTABLE SERIES



11' Leading Edge Retractable (*Single-leg series*)

SW-8008-11LE-RBH-ALU

- Aluminum rebar hook
- 11' Working Length
- ANSI Leading Edge Compatible - For foot-level and sharp edge applications
- 3/16" (5mm) Steel Cable Lifeline
- Quick Attachment Bracket
- Cooling air mesh lined protective shock pack cover
- Class A (on overhead connections only)

11' Single-Leg Series Options:

- Steel snap hook
- Aluminum snap hook
- Steel rebar hook

RETRACTABLES & LANYARDS



11' Leading Edge Retractable (*Dual-leg series*)

SW-8008-11LE-RBH-ALU-DL

- Aluminum rebar hooks
- 11' Working Length
- ANSI Leading Edge Compatible - For foot-level and sharp edge applications
- 3/16" (5mm) Steel Cable Lifeline
- Quick Attachment Bracket
- Cooling air mesh lined protective shock pack cover
- Class A (on overhead connections only)

11' Dual-Leg Series Options:

Dual-leg Configuration (100% Tie-Off)

- Steel snap hooks
- Aluminum snap hooks
- Steel rebar hooks

CONNECTORS

RETRACTABLES / ENERGY ABSORBING LANYARDS

CLASS A RETRACTABLES



A SW-8008-10-ALU-RBH-DL

- 10' Galvanized cable
- Lightweight
- Fall indicator located in energy absorber
- Meets ANSI Z359.14 - Class A Standards

*Unit is suggest to be used with a Fixed Back D-ring Harness

Other Options:

- SW-8008-10** Single leg with forged steel snap hook
- SW-8008-10-ALU** Single leg with aluminum snap hook
- SW-8008-10-ALU-DL** Dual leg with aluminum snap hooks
- SW-8008-10-ALU-RBH** Single leg with aluminum rebar hook
- SW-8008-10-DL** Dual leg with forged steel snap hooks
- SW-8008-10-RBH** Single leg with forged steel rebar hook
- SW-8008-10-RBH-DL** Dual leg with forged steel rebar hooks

Other Lengths Available:

- FS-FSP1211-G** 11' with snap hook
- FS-FSP1211-G-RBH** 11' with rebar hook
- FS-FSP1215-G** 15' with snap hook
- FS-FSP1220-G** 20' with snap hook

CLASS B RETRACTABLES



B FS-FSP1230-G

- 30' cable
- 3/16" Galvanized cable
- Includes steel carabiner
- 3,600 lbs gate-rated indicator snap hook
- Swivel top
- Engraved housing
- Meets ANSI Z359.14 - Class B Standards

Other Options:

- FS-FSP1250-G** 50'
- FS-FSP1265-G** 65'

Web Options:

- FS-FSP1420-W** 20'

Leading Edge Options:

- FS-FSP9020** 20'
- FS-FSP9030** 30'
- FS-FSP9050** 50'



C FS-EX1080-G

- 80' Length
- 3,600 lbs gate-rated snap hook
- Reinforced carry handle
- Heavy duty housing
- Meets OSHA 1926-502 and ANSI Z359.14

Other Options:

- FS-EX10-100-G** 100'



D FS-EX1530-W

- 30' Length
- 3,600 lbs gate-rated hook
- Heavy duty housing
- Meets OSHA 1926-502 and ANSI Z359.14

Other Options:

- FS-EX1540-W** 40'
- FS-EX1550-W** 50'

*Safewaze Retractable include Standard Steel Carabiner

CONNECTORS

RETRACTABLES / ENERGY ABSORBING LANYARDS

ENERGY ABSORBING LANYARDS



A FS450 / Tie-Back

- 6' Length
- 1" Polyester webbing with tensile strength greater than 5,000 lbs
- Double locking tie-back and snap hook

Other Options:
FS451 Dual-leg 100% tie off

A



B FS455

- 6' Length
- 1" Polyester webbing with tensile strength greater than 5,000 lbs
- Adjustable tie-back ring and double locking snap hooks

Other Options:
FS456 Dual-leg 100% tie off

B

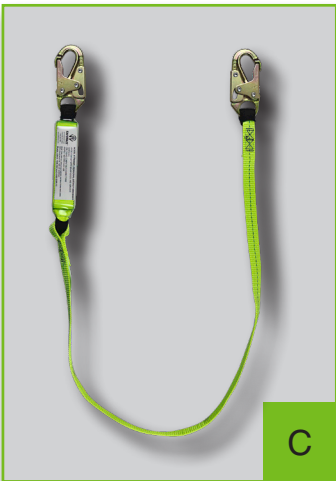

C FS560

- 6' Length
- 1" Polyester webbing with tensile strength greater than 5,000 lbs
- Double locking snap hooks

Other Options:
FS560-AJ 4'-6' Adjustable range with double locking snap hooks (*Available in Dual-leg 100% tie off)
FS561 Dual-leg 100% tie off

C



D FS560-CA

- 6' Length
- 5/16" Coated Cable
- Shock absorber
- Snap hooks

Other Options:
FS561-CA Dual-leg 100% tie off

D



E FS565

- 6' Length
- 1" Polyester webbing with tensile strength greater than 5,000 lbs
- Rebar hook designed to fit Symons Form

Other Options:
FS566 Dual leg 100% tie off

E



F FS565-AJ

- Adjustable range 4' - 6'
- 1" Polyester webbing with tensile strength greater than 5,000 lbs
- Rebar hook designed to fit Symons Form

Other Options:
FS566-AJ Dual-leg 100% tie off

F

RETRACTABLES & LANYARDS

CONNECTORS

RETRACTABLES / ENERGY ABSORBING LANYARDS

ENERGY ABSORBING LANYARDS

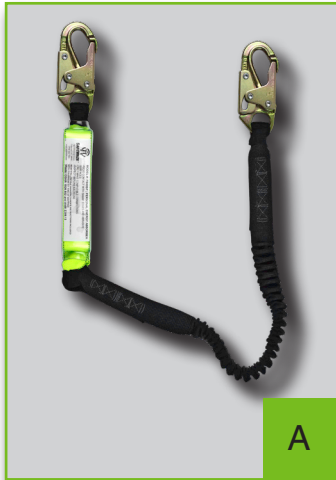

A FS570

- 4' - 6' Maneuverability
- 1" Polyester webbing with tensile strength greater than 5,000 lbs
- Double locking snap hooks
- Elastic webbing

Other Options:
FS571 Dual-leg 100% tie off



B FS575

- 4' - 6' Maneuverability
- 1" Polyester webbing with tensile strength greater than 5,000 lbs
- Elastic webbing
- Rebar hook designed to fit Symons Form

Other Options:
FS576 Dual-leg 100% tie off



C FS580

- 6' Length
- Tubular webbing with internal energy absorber
- Light weight
- Double locking snap hooks

Other Options:
FS581 Dual-leg 100% tie off



D FS585

- 6' Length
- Tubular webbing with internal energy absorber
- Light weight
- Rebar hook designed to fit Symons Form

Other Options:
FS586 Dual-leg 100% tie off



E FS590

- 4' - 6' Maneuverability
- Stretch tubular webbing with internal energy absorber
- Contracts to length that reduces the risk of tripping
- Double locking snap hooks

Other Options:
FS591 Dual-leg 100% tie off



F FS595

- 4' - 6' Maneuverability
- Stretch tubular webbing with internal energy absorber
- Contracts to length that reduces the risk of tripping
- Rebar hook designed to fit Symons Form

Other Options:
FS596 Dual-leg 100% tie off
FS596-ALU Dual-leg 100% tie off, aluminum hardware

*ALL snap and rebar hooks are 3,600 lbs gate rated

CONNECTORS

RETRACTABLES / ENERGY ABSORBING LANYARDS

ENERGY ABSORBING LANYARDS / EXTENDERS



G FS66100

- 4' - 6' Maneuverability
- Stretch tubular webbing with internal energy absorber
- External O-ring allows for retractable on lanyard attachment to convert to a dual purpose unit

Other Options:
FS66150 Dual-leg 100% tie off



H FS88761-FF-ALU

- Rated for 12' free fall with 400 lb. capacity
- Double energy absorbing design
- External D-rings for rescue
- Aluminum hardware



I FS33215

- 6' Length
- 5/8" Rope
- Double locking snap hooks

Other Options:
FS33216 Dual-leg 100% tie off



J FS578

- Adjustable range 4' - 6'
- Convenient rescue rings
- Rebar hooks on anchorage end



K FS8800SP-D

- Energy absorber with double locking snap hook on one end and D-ring on the other

Other Options:
FS8800SP-L Cinching loop on one end



L SW560-AF-DE

- 6' Length
- Arc flash webbing
- Energy absorber
- Dielectric snap hooks

Other Options:
SW560-AF-DE-SE Arc flash webbing, Dielectric snap hook, with soft eye
FS560-AF Arc flash webbing, and steel snap hooks
FS560-AF-SE Arc flash webbing, steel snap hook, and soft eye

RETRACTABLES & LANYARDS

*ALL snap and rebar hooks are 3,600 lbs gate rated

CONNECTORS

RETRACTABLES / ENERGY ABSORBING LANYARDS

ENERGY ABSORBING LANYARDS



A FS88660-HW

- 6' Length
- Heavy weight
- 1.25" Polyester webbing with tensile strength greater than 5,000 lbs
- Double locking snap hooks
- Rated at 400 lbs

Other Options:
FS88661-HW Dual-leg 100% tie off



B FS88665-HW

- 6' Length
- Heavy weight
- 1.25" Polyester webbing tensile strength greater than 5,000 lbs
- Rebar hook designed to fit Symons Form
- Rated at 400 lbs

Other Options:
FS88666-HW Dual-leg 100% tie off



C FS77330-FR

- Fire rated 700° F
- Nomex® Cover/Kevlar® Core
- Double locking snap hooks

Other Options:
FS77330-DL-FR Dual-leg 100% tie off



D FS88560-E

- V-LINE
- 6' Length
- 1" Polyester webbing with tensile strength greater than 5,000 lbs
- Double locking snap hooks

Other Options:
FS88561 Dual-leg 100% tie off

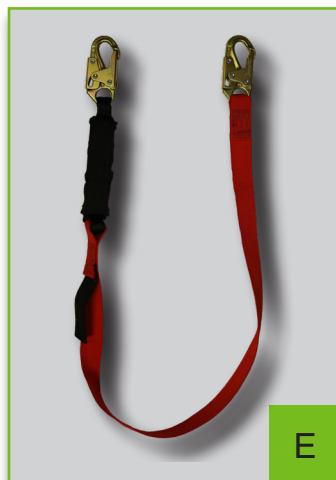

E FS77430-WE

- Designed for welders
- Nomex® Cover/Polyester Core
- Prevents welding burn slag
- Surface at 700° F
- Double locking snap hooks

Other Options:
FS77430-WE-DL Dual-leg 100% tie off
FS77435-WE-DL Dual-leg 100% tie off with rebar hooks



F FS88565-E

- V-LINE
- 6' Length
- 1" Polyester webbing with tensile strength greater than 5,000 lbs
- Rebar hook designed to fit Symons form

Other Options:
FS88566-E Dual-leg 100% tie off

*ALL snap and rebar hooks are 3,600 lbs gate rated

CONNECTORS

RETRACTABLES / ENERGY ABSORBING LANYARDS / EXTENDERS

ENERGY ABSORBING LANYARDS



G FS88580

- V-LINE
- 6' Length
- Stretch Tubular Webbing allows for maneuverability
- Streamline shock limits fall to 3.5 ft
- Double locking snap hooks

Other Options:
FS88581 Dual-leg with snap hooks

G



H FS88585

- V-LINE
- 6' Length
- Stretch Tubular Webbing allows for maneuverability
- Streamline shock limits fall to 3.5 ft
- 1 Snap hook, and 1 Rebar hook

Other Options:
FS88586 Dual-leg with Rebar Hooks

H

J FS88595



I FS88590

- V-LINE
- Adjustable range 4' - 6'
- Stretch Tubular Webbing allows for maneuverability
- High-strength polyester stitching
- Double locking snap hooks

Other Options:
FS88591 Dual-leg with double-locking snap hooks

I



- V-LINE
- 4' - 6' Length
- Stretch Tubular Webbing allows for maneuverability
- Elastic webbing allows for maneuverability
- Rebar hook designed to fit Symons Form
- 1 Snap hook, and 1 Rebar hook

Other Options:
FS88596 Dual-Leg with Rebar Hooks

J

K FS813

- 18" D-ring extender with double locking snap hook on one end and D-ring on the other



K

RETRACTABLES & LANYARDS

Our energy absorbing lanyards provide maneuverability, durability, and flexibility. As a connector, they help complete your 3-point fall protection system.

*ALL snap and rebar hooks are 3,600 lbs gate rated

ANCHORS

CARABINERS / POSITIONING DEVICES / ROPE, VERTICAL ROPE LIFELINES, & FALL ARRESTERS

CARABINERS



A

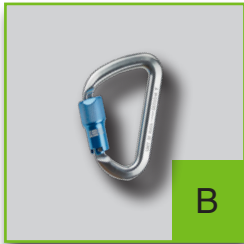

B

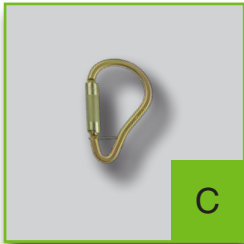

C



D



E



F

A FS1015

- 11/16" Steel

B FS1016-GR

- 11/16" Aluminum

C FS1017

- 1 3/4" Steel

D FS1018

- 2" Aluminum

E FS1025

- 1 3/16" Steel

F FS1026

- 2 5/64" Steel

POSITIONING DEVICES



G

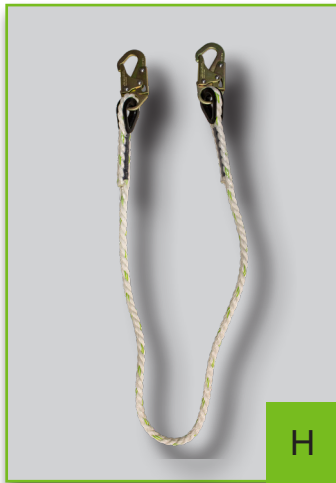

H

G FS060 (26") & FS061 (19")

- Chain assembly
- Large steel swivel rebar hook, 3,600 lb gate-rated double locking snap hooks

Other Options:

FS060-E 2 Adjustable quick links (26") non-swivel

FS060-GCC Gates Column Clamp (26")

FS060-WEB (18")

H FS33210

- 6' 5/8" Polydac rope positioning lanyard with locking snap hooks

I FS33200

- 6' rope positioning lanyard with wear sleeve, dual-cam fall arrester, one snap hook and a thimble eye

J FS88860

- 6' Positioning lanyard with double locking snap hooks

- 1" Polyester webbing

Other Options:

FS33310 Adjustable with range of 4' - 6'



I



J

ANCHORS

CARABINERS / POSITIONING DEVICES / ROPE, VERTICAL ROPE LIFELINES, & FALL ARRESTERS

ROPE / ROPE LIFELINES / FALL ARRESTERS

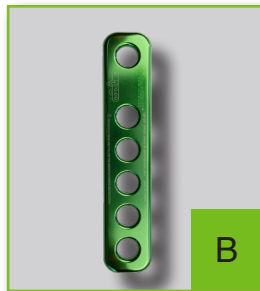

A Bulk Rope

- Heavy duty Dacron construction, Polyester jacket ensures abrasion resistance, durability, and low elasticity

Available Lengths:

FS700-58600: 5/8" - Bulk Rope /600'
FS700-581200: 5/8" - Bulk Rope /1200'

B FS875 / Rope Termination Plate

- Rope anchor replaces splicing in synthetic rope
- Use with 5/8" and 3/4" rope

*Carabiner and rope sold separately



C Rope Lifelines

- Rope lifelines assembled from our high quality bulk rope

Available Lengths:

FS700-25: 5/8" - Rope lifeline /25'
FS700-50: 5/8" - Rope lifeline /50'
FS700-75: 5/8" - Rope lifeline /75'
FS700-100: 5/8" - Rope lifeline /100'
FS700-150: 5/8" - Rope lifeline /150'
FS700-200: 5/8" - Rope lifeline /200'
FS700-250: 5/8" - Rope lifeline /250'
FS700-25GA: 5/8" - Rope lifeline /25' with FS1117 fall arrester attached
FS700-50GA: 5/8" - Rope lifeline /50' with FS1117 fall arrester attached
FS700-50GA-3E: 5/8" - Rope lifeline /50' with 3' energy absorbing lanyard attached to FS1117 fall arrester



D-F Fall Arresters

FS1117 Dual Cam - stationary
FS1118 Removable - trailing stainless steel, anti-panic
FS1120 Removable - trailing steel, anti-panic

ANCHORS / SPECIALTY
 HORIZONTAL LIFELINE
 KITS

ANCHORS

BEAM / REMOVABLE / MINING / VERSATILE / ROOF / ANCHOR STRAPS / SPECIALTY

BEAM / REMOVABLE CONCRETE & STEEL / MINING



A FS860 / Beam

- Premier anchor
- Reduced friction nylon rollers
- Center positioning retainer prevents jamming on beam
- Double - toothed pawl
- Range 3 1/2" to 14"
- Overall length 18.25"
- Beam flange thickness capacity 1 1/4"

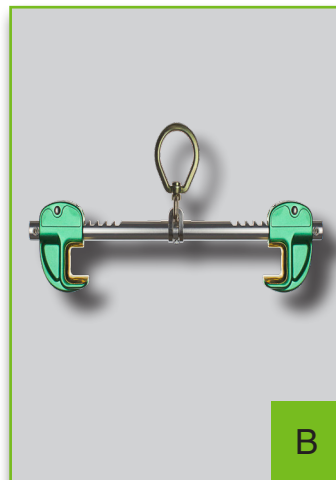

B FS861 / Beam

- Most affordable quality anchor
- One-handed quick release latch
- D-ring prevents jamming on beam flange for smoother sliding
- Range 3 1/2" to 13 1/4"
- Overall Length 18.50"
- Beam flange thickness capacity 1 1/4"

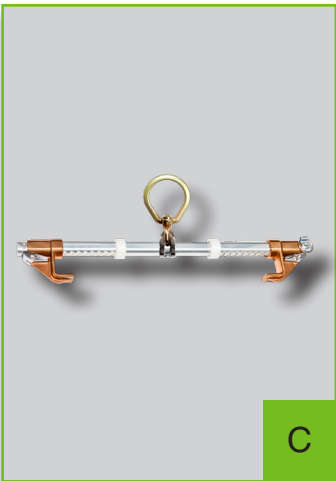

C FS-EX210 / Beam

- The lightest and nimblest of its kind
- Unique components, including our swivel D-ring technology
- Range 3 1/2" to 14"
- Overall Length 20"



D FS865 / Stationary

- Fits vertical and horizontal positions
- 2 Handled locking wing nuts
- 3 Attachment points (snap hook, carabiners, lifelines)
- Fits up to 12" wide and 1" thickness
- Overall Length 20"



C FS-EX211 / Beam

- The lightest and nimblest of its kind
- Unique components, including our swivel D-ring technology
- Range 12" - 30"



F FS885 / Girder Grip

- Mobile anchorage point for metal/steel structures
- Can be used vertically or horizontally
- Fits 3/4" diameter hole
- Overall Length 9.5"

ANCHORS

BEAM / REMOVABLE / MINING / VERSATILE / ROOF / ANCHOR STRAPS / SPECIALTY

BEAM / REMOVABLE CONCRETE & STEEL / MINING

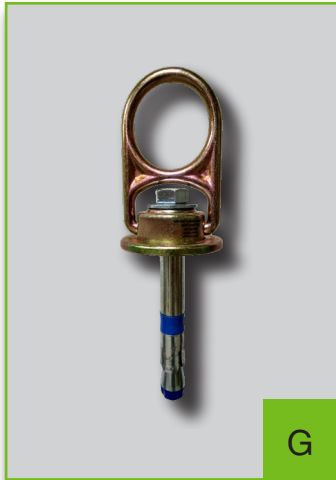

G FS-EX214 / Concrete

- Removable
- Anchor swivel, 10K concrete anchor with 3/4" sleeve anchor
- Bolt 5 3/4" / Mega Swivel 4 1/2" / Overall Length 8 3/4"

Other Options:
FS-EX216 Mega Swivel 10K Steel Anchor with Steel Mounting Kit



H FS-EX110 / Concrete

- Removable
- For use in concrete substrate only
- Inserts and removes in seconds
- 1" Fall Protection with 10,000 lbs max capacity
- Overall length 13.75"

Our diverse line of anchors provide the right secure connection point for your job site. Whether you are working on a roof, with concrete, on a steel beam, or a parapet wall, and every scenario in between, we have an anchor for you.

ANCHORS / SPECIALTY
 HORIZONTAL LIFELINE
 KITS



I FS876 / Concrete

- Removable
- Exclusive "Easy Button" feature boosts productivity by providing immediate anchor removal
- Virtually eliminates the need for tools to remove a stuck anchor from the hole – giving the user instant mobility
- 5,000 lbs max capacity
- 11" overall length

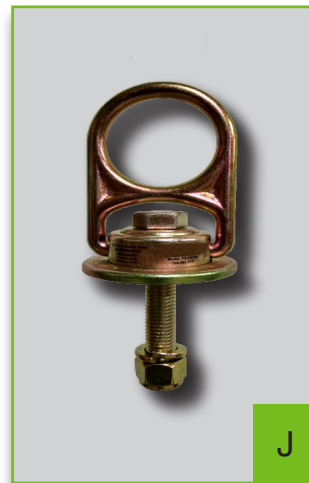

J FS216 / Concrete

- Removable
- Zinc plated steel
- Can be used in horizontal, vertical, and overhead applications
- 7" overall length

ANCHORS

BEAM / REMOVABLE / MINING / VERSATILE / ROOF / ANCHOR STRAPS / SPECIALTY

VERSATILE



A FS-EX225 / Steel

- Anchor swivel
- 5K 316SS Steel Kit
- 5/8"x4" 316SS bolt, flat washer, nylon locknut

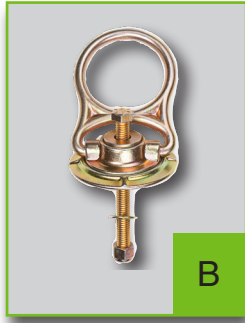

B FS-EX232 / Enter

- Mega Swivel
- Zinc Plated Steel
- Can be used in horizontal, vertical and overhead applications



C FS888 / Steel

- Designed for free moving
- Minimum tensile strength 5,000 lbs
- Zinc plated steel

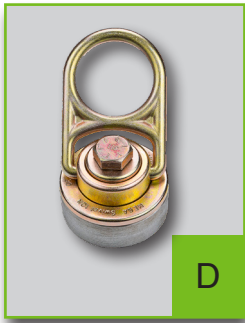

D FS-EX219 Weld on Puck

- Mega Swivel 10K D-ring
- Puck with 5/8-11" Spirallok® thread
- 5/8-11x1.75" G8 HH bolt

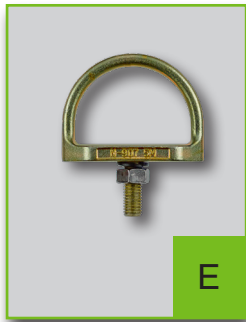

E FS887 D-Bolt Anchor

- Single point anchor
- 5K anchor point for bolt on applications on approved structures 3" or less

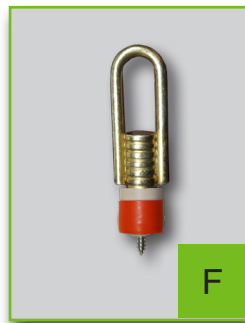

F SW-EX100 Straight Loop Insert / Concrete

- Pre-installed receptacle that is cast-in place during construction of the surface for the purpose of attaching an anchorage connector
- Twice the strength rating of a concrete strap
- Plastic bolt included is 5/8"-11.1"
- Works with Mega Swivel SW-EX150
- Compatible with any anchorage connector that is designed for use with Grade 8, 5/8"-11" bolt

Other Options:

SW-EX100-KIT includes Straight loop insert, mega swivel 10k anchor, precast bolt assembly

ANCHORS

BEAM / REMOVABLE / MINING / VERSATILE / ROOF / ANCHOR STRAPS / SPECIALTY

VERSATILE

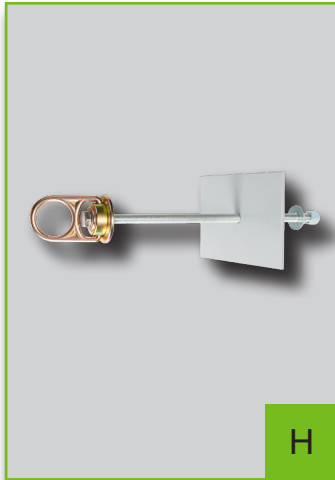

H FS-EX220

- Backing Plate anchor point
 - Designed for reinforced cinder block, chillers, or AC unit walls
 - Many other applications
- *(Kit not included, back plate only)



I FS-EX234

- Drop Through anchor point
- 1/4" Steel plate with a 8 1/2' cable attached to a swiveling D-ring
- Drops through opening in any 1-3/4"-2" substrate
- To be used as a 5,000 lbs overhead anchor



J FS-EX325

- 12" Permanent Roof Anchor
- Easy Installation
- For use on wood, concrete, and steel
- Can be used with horizontal lifelines



K FS-EX326

- 18" Permanent Roof Anchor
- For use on wood, concrete, and steel
- Galvanized steel
- Can be used with horizontal lifelines

ANCHORS / SPECIALTY
HORIZONTAL LIFELINE
KITS

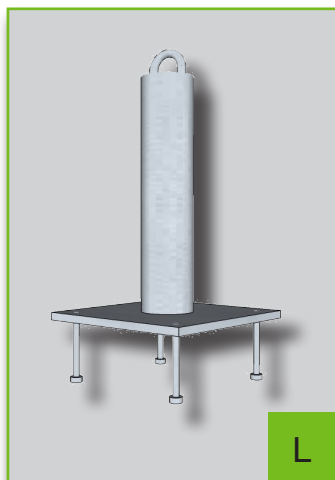

L SW-EX280

- 14.5" Cast into concrete Tie-Back Anchor
- Easy Installation
- Engineered to an ultimate load of 5,400 lbs
- Pre-engineered for cast in place applications
- Single person use

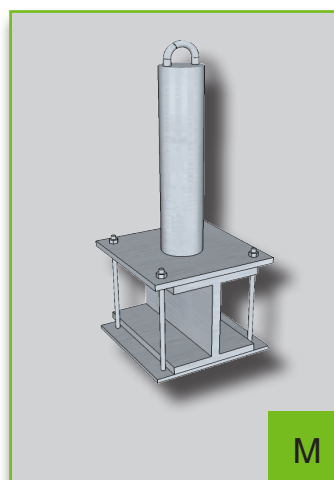

M SW-EX281

- 14.5" I-Beam Wrap Tie-Back Anchor
- Easy Installation
- Engineered to an ultimate load of 5,400 lbs
- Single person use

ANCHORS

BEAM / REMOVABLE / MINING / VERSATILE / ROOF / ANCHOR STRAPS / SPECIALTY

ROOF



A FS870

- Reusable roof anchor
- Galvanized steel



B FS871

- Disposable roof anchor
- Galvanized steel



C FS-EX310-1

- Reusable roof anchor for wood or metal
- Installs with 3 threaded fasteners or 6 nails



D FS-EX311

- Single standing seam roof anchor
- Designed for sloped or flat roofs



E FS873

- Deluxe swivel anchor with D-ring and slot for retractable device

*(Retractable not included)

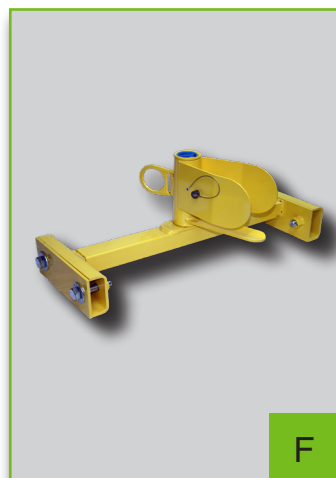

F FS874

- Deluxe standing seam anchor with D-ring and, slot for retractable device

ANCHORS

BEAM / REMOVABLE / MINING / VERSATILE / ROOF / ANCHOR STRAPS / SPECIALTY

ANCHOR STRAPS



G FS810

- 6' 1 3/4" polyester webbing with 3" reinforced webbing
- *Other lengths available



H FS811

- 6' 1 3/4" polyester webbing
- *Other lengths available



I FS812

- Adjustable
- 4'-6'; 1-3/4" polyester webbing

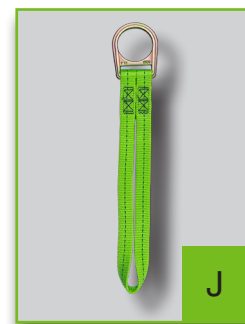

J FS815

- 18" scaffold anchor



K FS830

- 5/16" coated cable flip line with loop ends
- 24" length



L FS830-C6

- 6' coated cable cross arm strap
- Pass through O-rings



M FS880

- Heavy duty 4' length
- Wear sleeve
- D-ring and sewn eye
- *Other lengths available

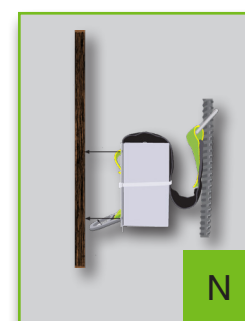

N FS-EX302

- 2" Galvanized steel holding box
- Heavy-duty 4' length
- 2 D-rings
- Other Options FS-EX304** 6' length

ANCHORS / SPECIALTY
HORIZONTAL LIFELINE
KITS

ANCHORS

BEAM / REMOVABLE / MINING / VERSATILE / ROOF / ANCHOR STRAPS / SPECIALTY

ANCHOR STRAPS



A FS814

- Anchor extension with rebar hook



B FS-EX400-15

- Ratcheting tensioner
- 15' length
- For use around booms, columns, and posts

Other Options FS-EX400-30 30' length



C FS88811-HW

- 6' Heavyweight cross arm strap
- 1 3/4" Heavyweight polyester webbing
- Rated up to 400 lbs.

SPECIALTY



A Parapet Wall Anchor

SW900

- Easy instillation method for high productivity
- Portable and reusable
- High strength steel construction
- Built-in tie-off D-ring
- Non-penetrating rubber padded design eliminating parapet wall damage
- 2 tightening handles for even force distribution on the parapet wall



B Window/Door Jamb Anchor

SW901

- Easily adjustable design for quick installations
- Light weight aluminum construction
- Stainless steel connection point
- Eliminates structural damage
- Portable and reusable
- Built with durable corrosion resistant materials

ANCHORS

BEAM / REMOVABLE / MINING / VERSATILE / ROOF / ANCHOR STRAPS / SPECIALTY

HORIZONTAL LIFELINE KITS

	<p>2-PERSON HORIZONTAL LIFELINE KIT</p>
	<p>FS805-60KM</p> <ul style="list-style-type: none"> • 2-Person • Portable 60', 80' or 100' Kernmantle rope horizontal lifeline • 2 Carabiners • 2 Cross-arm straps • 2 O-rings • Energy absorber • Steel Tensioner • Transport bag

	<p>2-PERSON HORIZONTAL LIFELINE KIT / CABLE</p>
	<p>FS806</p> <ul style="list-style-type: none"> • 2 Person • 60' Cable line • Turnbuckle • 2 Carabiners • 2 O-rings • 5/16" Fist grips • 2 Cross arm straps • Energy absorber • Transport bag

	<p>4-PERSON HORIZONTAL LIFELINE KIT</p>
	<p>FS808</p> <ul style="list-style-type: none"> • 4-Person portable rope horizontal lifeline 60' 80' or 100' Rope • 2 Carabiners • 1 Captive Swivel Eye • 2 Cross-arm straps • 1 Tensioner • 4 O-rings • Transport bag

**ANCHORS / SPECIALTY
HORIZONTAL LIFELINE
KITS**

HORIZONTAL LIFELINE

MOBILE SAFELINK HORIZONTAL LIFELINE

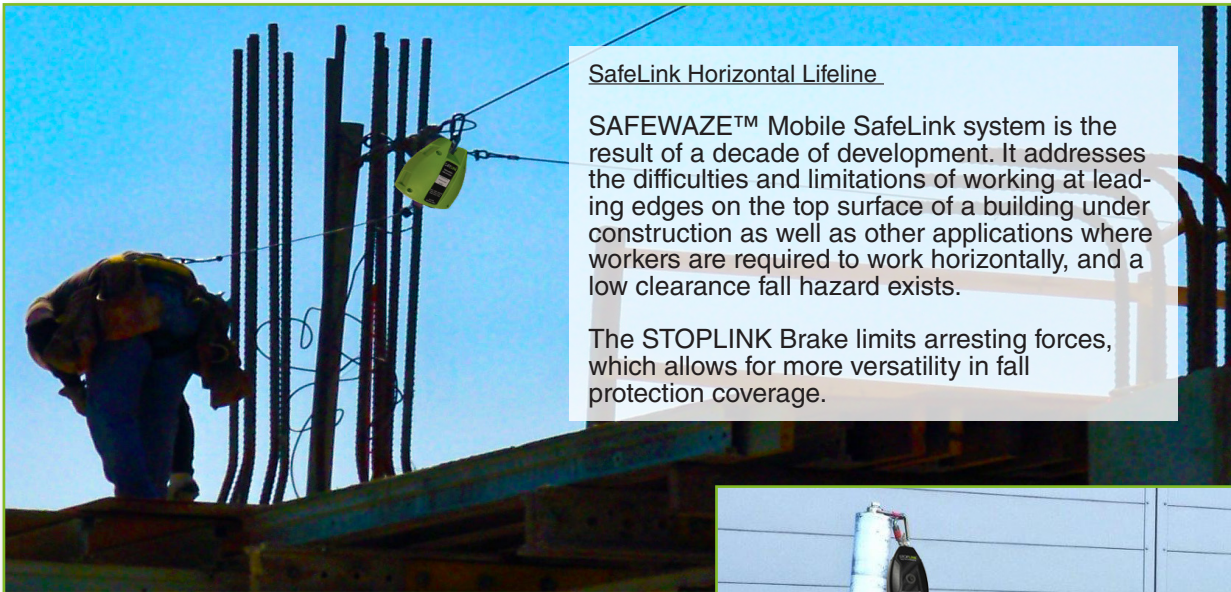

Safelink Horizontal Lifeline

SAFEWAZE™ Mobile SafeLink system is the result of a decade of development. It addresses the difficulties and limitations of working at leading edges on the top surface of a building under construction as well as other applications where workers are required to work horizontally, and a low clearance fall hazard exists.

The STOPLINK Brake limits arresting forces, which allows for more versatility in fall protection coverage.

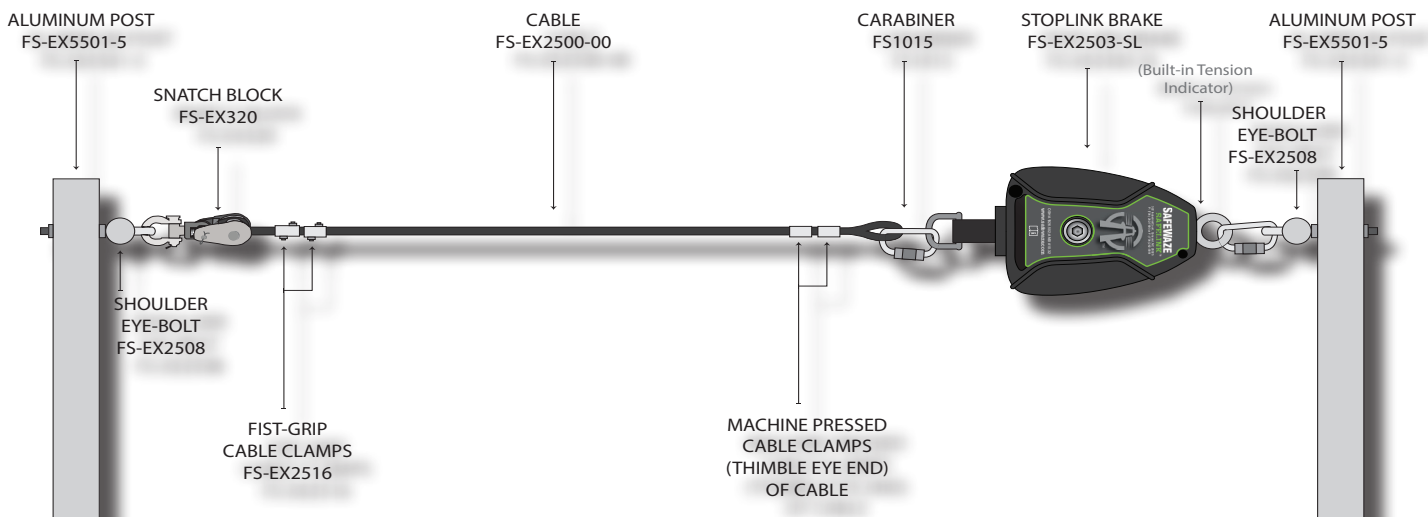

*Can be used with PRO or PRO+ Harnesses

HORIZONTAL LIFELINE

MOBILE SAFELINK HORIZONTAL LIFELINE



A



B

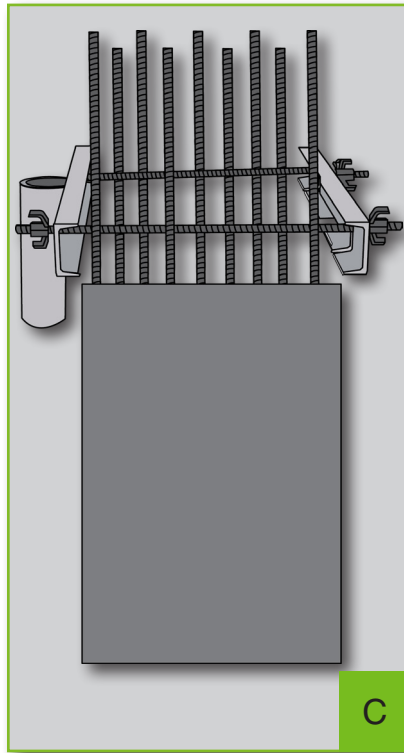

C



D

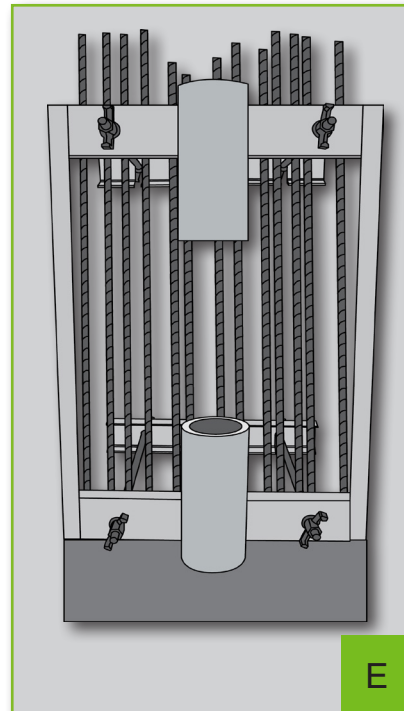

E

A StopLink Brake Assembly

FS-EX2503-SL

- Designed to limit the maximum arrest load to no more than 1,000 lbf on end anchorages
- Aluminum housing
- Ultra high molecular weight webbing
- Stainless steel connectors

B SafeLink Cable Retractable

FS-EX2530-G-SL

- 30' Length
- High strength polymer housing
- 3/16" galvanized steel cable
- Forged steel snap hook
- Ceramic entry with cleaning brush to reduce internal contamination
- Heavy duty rubber shock protector and pull grip
- Rated for subdued edges

Other Options:

FS-EX2550-G-SL: 50'

C Form Link

FS-EX2502

- Column mounted rebar bracket for mounting post

D Rebar Link

FS-EX2507

- Mounting on stirrup rebar

E EZ Link

FS-EX2502-DBL

- Mounting on stirrup rebar

SafeLink Kit Options:

FS-EX10000: SafeLink Come-A-Long

FS-EX10500: SafeLink Turnbuckle

MOBILE SAFELINK
HORIZONTAL
LIFELINE

SPECIALTY

RESCUE



OSHA regulations state that a rescue plan must be in place in the event of a fall when working at heights. SAFEWAZE offers a variety of products to assist you in your rescue planning operations.

A Power Assisted Rescue Descender Kit

FS903PR-130

- Manual Ascend / Descend device with carabiner
- Rescue hand wheel with drill attachment point
- 130' Rescue rope (steel carabiner on each end)
- (1) FS812 Cross-Arm strap
- 12' Extension rescue pole
- Kit storage bag with pole compartment

SYSTEM FEATURES:

The Power Assisted Rescue Descender System is the most versatile constant rate descender on the market today. It offers the versatility of rescue, evacuation, and assisted lifting capabilities. The device is ideal for emergency escape from high rise structures.

- **Rope Friction Points-** For operator controlled descents (both sides)
- **Heat Dissipating Fins-** Cooling fins are an integral part of the housing, it provides removal of heat build up during a descent
- **Lock-off Points-** Non-mechanical integrated lock-off points (both sides) for use during remote or direct rescue
- **Durable Wear Points-** Replaceable wear points for extended life and increased durability.
- *Drill attachment point located on the other side



B Evacuation Descender

FS905-300

- Evacuation/Manual Descend device with carabiner
- Allows for quick, and easy descent for user to reach the ground safely from high rise structures
- 300' Rescue rope (steel carabiner on each end)
- (1) FS812 Cross-Arm strap
- Storage bag

SPECIALTY

RESCUE & CONFINED SPACE



C



D



E

C Suspension Trauma Steps

FS902

- 6' Length web step system
- Connect at dorsal D-ring
- Relieves body pressure

D Rescue Ladder

FS-EX243

- 18' fast drop ladder in ballistic nylon deployment bag
- ANSI Steel carabiner for quick attachment

Other Options:

FS-EX243-BL Belay System which has a rope pulley that allows co-worker to raise the individual

E Fixed Ladder Climb System

FS983

- 3/8" Diameter cable system, 2 man safe operation
- ANSI A 14.3 Ladder safety requirements
- Removable dual cam wire grab (FS1119): please specify 3/8" or 5/16" cable
- Sealed anchor head with impact attenuator
- Cable stand-off (every 25ft)

F Working Chair

FS982

- Lightweight chair for suspension application
- Ideal for confined space
- Birch plywood
- High-strength polyester stitching
- Heat-treated alloy steel D-ring

G Confined Space System

FS980

- FS970 Aluminum tripod with carry bag
- FS960-65 65' 3-way recovery system
- FS958-65 65' Material winch

Other Options:

FS981 65' 3-way recovery system, carabiner and tripod carry bag (same as FS980 without winch)



F



G



Fall Clearance

For your fall protection to work properly, its crucial to have the right fall clearance. Our Fall Clearance Guide helps you calculate a safe working distance based on physical attributes and the equipment you are using.

Connecting Devices

Must Anchor Above Head



Harnesses

Must Connect Connecting Device to D-Ring

Fall Protection ABC's

Fall protection is a system of products that work together to keep workers safe. Remember to follow your ABC's to make sure you have the correct components for a complete fall protection system.

A – Anchor

B – Bodywear (Harness)

C – Connecting Device (SRL or Lanyard)

Fall Clearance Chart*

***Diagram shown is an example fall clearance calculation ONLY.

***Calculations are based on SRD anchored above head

For all applications: worker weight capacity range (including all clothing, tools, and equipment) is 130-310 lbs

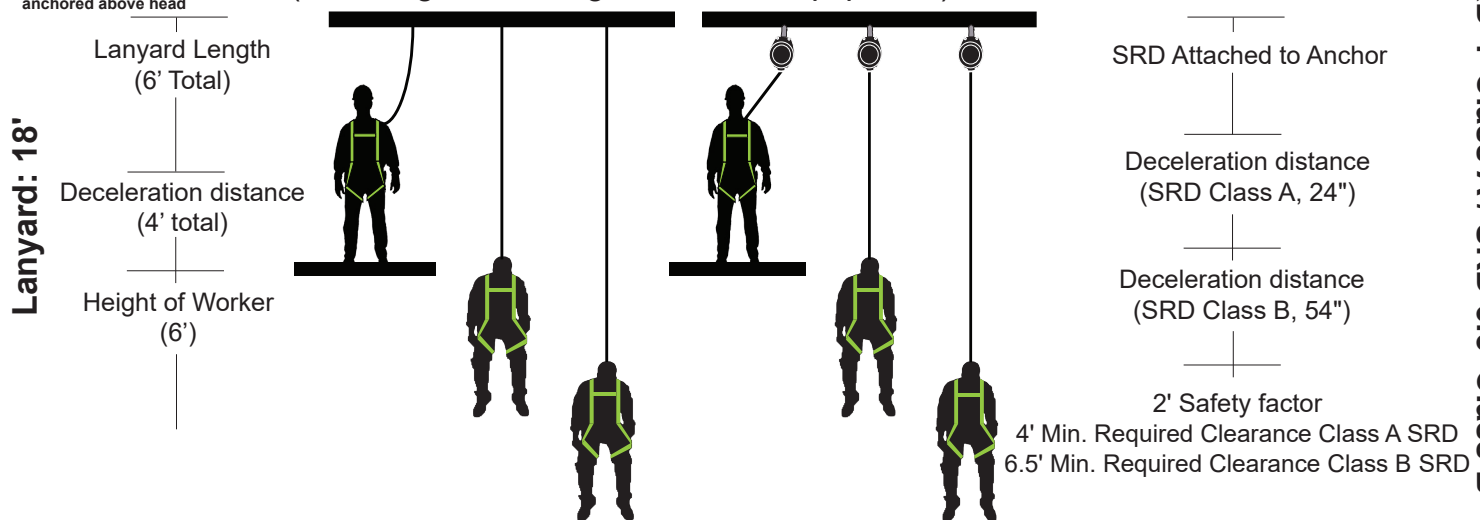

SRD 4' Class A / SRD 6.5' Class B

4' Min. Required Clearance Class A SRD
6.5' Min. Required Clearance Class B SRD



SAFEWAZE

SAFEWAZE • 322 Industrial Ct. • Concord, NC 28025

P 704-262-7893 F 704-262-9051

SAFEWAZE.COM